

PRODUCT DATASHEET

FL PFM 80 W 3000 K SYM 100 BK

FLOODLIGHT 80 W | Versatile floodlight with up to 10000 lm light output



Areas of application

- Replacement for floodlights with halogen lamps
- Outdoor use (IP65)
- Industry
- Public areas
- Construction areas
- Building facades

Product benefits

- Bright, robust and durable
- Safe and very uniform illumination, due to frosted and tempered glass diffuser
- No upper light output ratio (ULOR 0%) when mounted at 0° tilt
- Energy savings of up to 90 % compared to halogen lamp floodlights
- 5 years guarantee

Product features

- Reflector-based, symmetric light distribution with 100° x 100° beam angle
- Integrated wide voltage driver, suitable for 100 - 277 V AC
- Surge protection: up to 6 kV (L/N-PE), 4 kV (L-N)
- Mounting bracket with 30° angle and wide rotation area
- Breather membrane to optimize air exchange, without compromising IP protection
- Pre-installed, flexible 1 m cable (H05RN-F), wrapped 3 x 1.0 mm² single wires



TECHNICAL DATA

Electrical data

Nominal wattage	80.00 W
Nominal voltage	100...277 V
Mains frequency	50...60 Hz
Nominal current	430 mA
Inrush current	14.8 A
Inrush current time T_{h50}	160 μ s
Max. no. of lum. on circuit break. B16 A	24
Max. no. of lum. on circuit break. C10 A	17
Max. no. of lum. on circuit break. C16 A	28
Power factor λ	> 0.90
Total harmonic distortion	< 20 %
Protection class	I
Operating mode	Integrated LED driver

Photometrical data

Luminous flux	8800 lm
Luminous efficacy	110 lm/W
Color temperature	3000 K
Light color (designation)	Warm White
Color rendering index Ra	≥ 80
Standard deviation of color matching	≤ 5 sdc _m
Luminous intensity	-
Flickering metric (Pst LM)	-
Stroboscope effect metric (SVM)	-
Photobiological safety group acc. to EN62778	RG1
Photobiological safety group acc. to EN62471	RG1
Beam angle	100 ° x 100 °

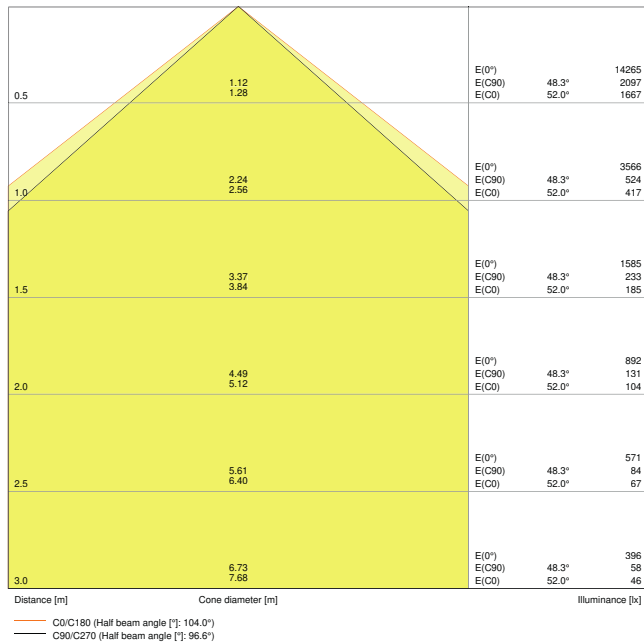

LDC typ cone

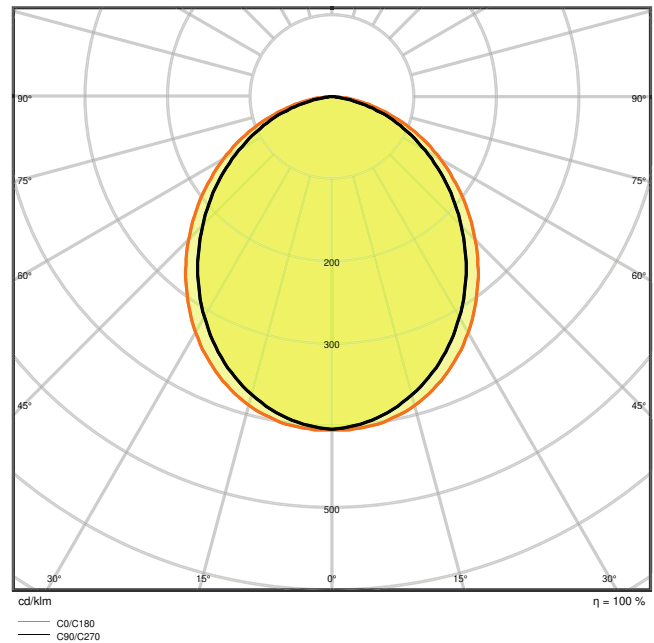

LDC typ polar

Dimensions & Weight

Length	335.00 mm
Width	250.00 mm
Height	55.00 mm
Product weight	2800.00 g
Cable length	1000 mm

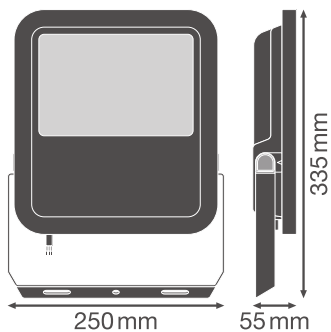

Materials & Colors

Product color	Black
Housing color	Black
Body material	Aluminum
Light emitting surface material	Glass
Glow Wire Test according to IEC 60695-2-12	650 °C
Mercury content	0.0 mg

Application & Mounting

Ambient temperature range	-30...+50 °C
Temperature range at storage	-40...+70 °C
Type of connection	Cable, 3-pole
Type of protection	IP65
Protection class IK (shock resistance)	IK08
Dimmable	No
Mounting type	Surface
Mounting location	Wall / Pole / Floor / Ceiling
Application environment	Outdoor
Adjustable	Yes
LED module replaceable	Not replaceable
With light source	Yes

Lifespan

Lifespan L70/B50 at 25 °C	70000 h
Lifespan L80/B10 at 25 °C	55000 h
Lifespan L90/B10 at 25 °C	35000 h
Number of switching cycles	100000

Control gear

Output current	870 mA
ECG - Output ripple current	< 35 %















Certificates & Standards

Standards	CE / CB / ENEC / EAC / RoHS
Luminaire with limited surface temperature, "D sign"	No
Ball shot safe	No

Safety advice

- Max. wind load surface 0.061 m²

DOWNLOAD DATA

Documents and certificates	
	User instruction
	Addon Technical Information
	Packaging insert
	Declarations Of Conformity CE
	Declarations Of Conformity UKCA
Photometric and lighting design files	
	IES file (IES)
	LDT file (Eulumdat)
	ULD file (DIALux)
	ROLF file (RELUX)
	UGR file (UGR table)
	LDC typ cone
	LDC typ polar
CAD/BIM files	
	CAD_STEP_3D
Tender texts	
	Tender documents

LOGISTICAL DATA

Product code	Packaging unit (Pieces/Unit)	Dimensions (length x width x height)	Gross weight	Volume
4058075422506	Folding box 1	62 mm x 257 mm x 352 mm	2957.00 g	5.61 dm ³
4058075422513	Shipping box 2	302 mm x 170 mm x 414 mm	6326.00 g	21.25 dm ³

The mentioned product code describes the smallest quantity unit which can be ordered. One shipping unit can contain one or more single products. When placing an order, for the quantity please enter single or multiples of a shipping unit.

ADDITIONAL CATALOG INFORMATION

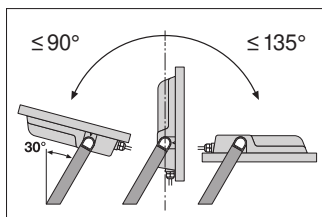

	A	B	C	⚙️	🔌
55 W	150	108	8,5	2x M8	0,046 m ²
80 W	150	108	10,5	2x M10	0,061 m ²
125 W	170	118	10,5	2x M10	0,083 m ²
160 W	170	118	12,5	2x M12	0,102 m ²
200 W	170	118	12,5	2x M12	0,124 m ²

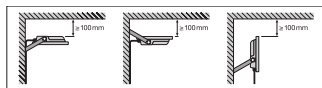
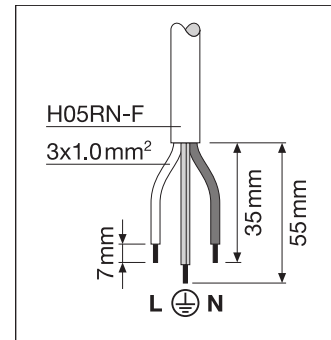

References / Links

- For Guarantee see www.ledvance.com/guarantee

DISCLAIMER

Subject to change without notice. Errors and omission excepted. Always make sure to use the most recent release.