

PRODUCT DATASHEET

TR SP ZOOM DIM D85 25 W 3000 K 97R WT

TRACKLIGHT SPOT ZOOM DIM | Dimmable 3-phase tracklight spot with mechanical zoom lens



Areas of application

- Direct replacement for luminaires using HID lamps
- Accent lighting
- Galleries, museums
- Fashion shops, accessories shops
- Shops, changing rooms, shop windows
- Hotels, restaurants, shops

Product benefits

- Dimmable 3-phase tracklight spot with mechanical zoom lens
- Included 3-phase adapter compatible with common tracks (GLOBAL, EUTRAC, POWERGEAR, STAFF, NORLUX, NUCO, NORDIC)
- No distraction of attention from the illuminated objects thanks to reduced design
- Low flicker light thanks to special electronic control gear
- 5 years guarantee

Product features

- Mechanical zoom lens with a beam angle of 15 ° to 55 °
- Dimmable (7% - 100%) via slider potentiometer directly on each luminaire
- Excellent color rendering index Ra: 97
- Color rendering index R_{a9}: > 90
- Initial color consistency: ≤ 4 SDCM
- Rotation angle: 350°, tilt angle: 90°
- Follows the unified LEDVANCE design language (SCALE design)
- Robust die-cast aluminum housing



- Available in matt white (like RAL9016), matt black (like RAL9004)
- Luminaire efficacy: up to 70 lm/W

TECHNICAL DATA

Electrical data

Nominal wattage	25.00 W
Nominal voltage	100...240 V
Mains frequency	50...60 Hz
Nominal current	120 mA
Inrush current	40 A
Inrush current time T_{h50}	< 50 μ s
Max. no. of lum. on circuit break. B16 A	37
Max. no. of lum. on circuit break. C10 A	30
Max. no. of lum. on circuit break. C16 A	48
Power factor λ	> 0.90
Total harmonic distortion	< 10 %
Protection class	I
Operating mode	Integrated LED driver

Photometrical data

Luminous flux	1500 lm
Luminous efficacy	60 lm/W
Color temperature	3000 K
Light color (designation)	Warm White
Color rendering index Ra	97
Standard deviation of color matching	≤ 4 sdc _m
Luminous intensity	-
Flickering metric (Pst LM)	-
Stroboscope effect metric (SVM)	-
Photobiological safety group acc. to EN62778	RG1
Beam angle	15°... 55°

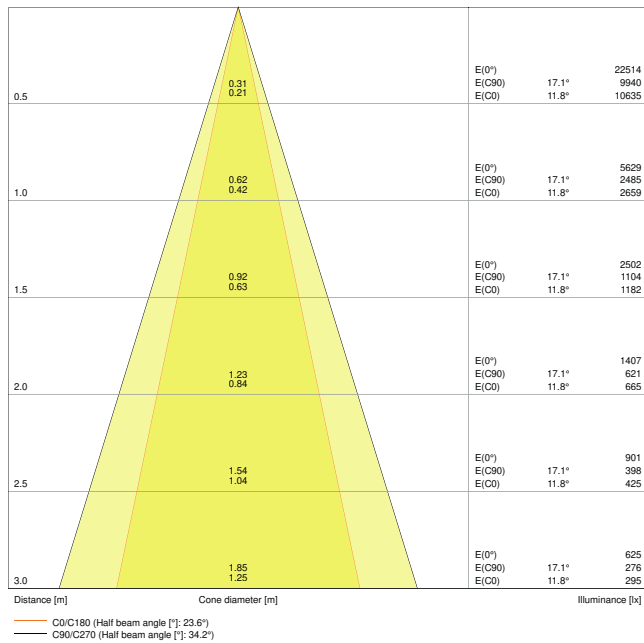

LDC typ cone

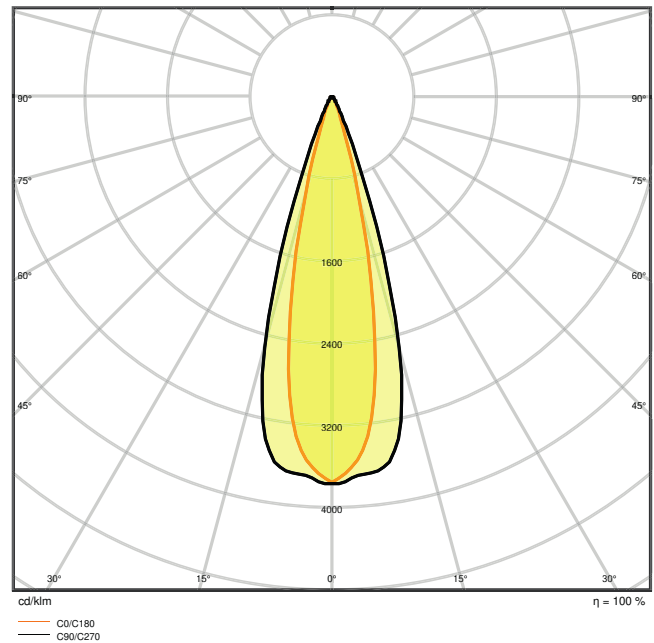

LDC typ polar

Dimensions & Weight

Diameter	85.00 mm
Length	93.00 mm
Height	265.00 mm
Product weight	1025.00 g

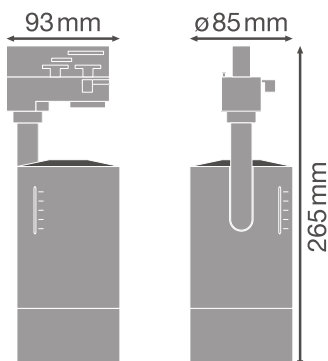

Materials & Colors

Product color	White
Housing color	White
Body material	Aluminum
Cover material	Polycarbonate (PC)
Light emitting surface material	Polycarbonate (PC)
Glow Wire Test according to IEC 60695-2-12	850 °C
Mercury content	0.0 mg

Application & Mounting

Ambient temperature range	-20...+40 °C
Type of connection	Adapter, 3-phase
Type of protection	IP20
Protection class IK (shock resistance)	IK03
Dimmable	Yes
Type of dimming	1-10V
Mounting type	Surface
Mounting location	Mounting track
Application environment	Indoor
Adjustable	Yes
LED module replaceable	Not replaceable
With light source	No

Lifespan

Lifespan L70/B50 at 25 °C	50000 h ¹⁾
Lifespan L80/B10 at 25 °C	35000 h ¹⁾
Lifespan L90/B10 at 25 °C	25000 h
Number of switching cycles	100000

¹⁾ t[h]: L70 / B50 @ 25 °C (Ta), t[h]: L80 / B10 @ 25 °C (Ta), t[h]: L90 / B10 @ 25 °C (Ta)

Control gear

ECG - Output voltage	27...42 V
ECG - Output ripple current	< 10 %





Certificates & Standards

Standards	CE / CB / ENEC / TÜV SÜD / EAC / RoHS
-----------	---------------------------------------





Luminaire with limited surface temperature, "D sign"	No
Ball shot safe	No

DOWNLOAD DATA

Documents and certificates

	User instruction
	Addon Technical Information
	Packaging insert
	Declarations Of Conformity CE
	Declarations Of Conformity UKCA

Photometric and lighting design files

	IES file (IES)
	LDT file (Eulumdat)
	ULD file (DIALux)
	ROLF file (RELUX)
	UGR file (UGR table)
	LDC typ cone
	LDC typ polar

Tender texts

	Tender documents
---	------------------

LOGISTICAL DATA

Product code	Packaging unit (Pieces/Unit)	Dimensions (length x width x height)	Gross weight	Volume
4058075335769	Folding box 1	120 mm x 120 mm x 300 mm	1146.00 g	4.32 dm ³

Product code	Packaging unit (Pieces/Unit)	Dimensions (length x width x height)	Gross weight	Volume
4058075335776	Shipping box 4	502 mm x 137 mm x 335 mm	4902.00 g	23.04 dm ³

The mentioned product code describes the smallest quantity unit which can be ordered. One shipping unit can contain one or more single products. When placing an order, for the quantity please enter single or multiples of a shipping unit.

ADDITIONAL CATALOG INFORMATION

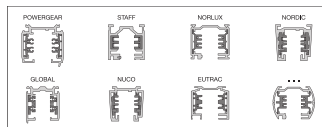
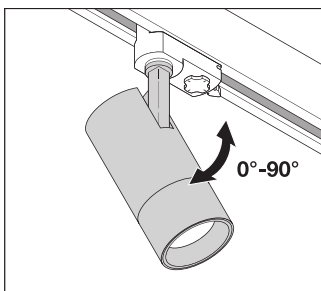
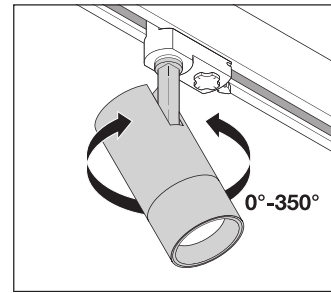
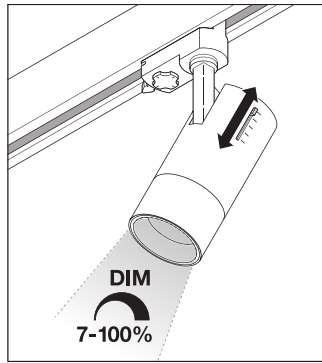
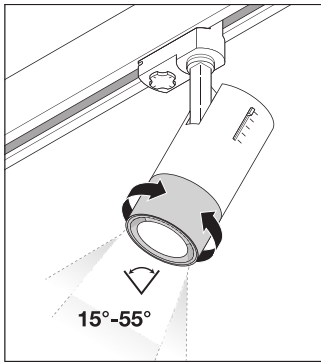

References / Links

- For Guarantee see www.ledvance.com/guarantee

DISCLAIMER

Subject to change without notice. Errors and omission excepted. Always make sure to use the most recent release.