

PRODUCT DATASHEET

DL COMFORT DN 205 20 W 3CCT IP54 WT

DOWNLIGHT COMFORT | Downlights with adjustable white light colors



Areas of application

- Direct replacement for luminaires with compact fluorescent lamps
- General illumination
- Bathrooms
- Kitchens
- Offices
- Corridors
- Foyers
- Shops
- Stairways

Product benefits

- Three light color in one luminaire: Warm White, Cool White, Daylight White
- Simple installation thanks to integrated driver
- Easy installation with fast connection
- 5 years guarantee

Product features

- Three light colors selectable via slide switch
- Type of protection: IP54
- Connector box with push wire terminal for tool-free connection
- Through wiring possible



TECHNICAL DATA

Electrical data

Nominal wattage	20.00 W
Nominal voltage	100...277 V
Mains frequency	50...60 Hz
Nominal current	230 mA
Inrush current	50 A
Inrush current time T_{h50}	100 μ s
Max. no. of lum. on circuit break. B16 A	13
Max. no. of lum. on circuit break. C10 A	10
Max. no. of lum. on circuit break. C16 A	17
Power factor λ	> 0.90
Total harmonic distortion	< 20 %
Protection class	I
Operating mode	Integrated LED driver

Photometrical data

Luminous flux	1720...1930 lm ¹⁾
Luminous efficacy	90 lm/W ²⁾
Color temperature	3000...5700 K
Light color (designation)	Warm White / Cool White / Cool Daylight
Color rendering index Ra	> 80
Standard deviation of color matching	< 5 sdcM
Luminous intensity	-
Flickering metric (Pst LM)	-
Stroboscope effect metric (SVM)	-
Photobiological safety group acc. to EN62778	RG0
Photobiological safety group acc. to EN62471	RG0
Beam angle	60 °

¹⁾ Luminous flux dependent on selected color temperature: 1720 lm@3000 K/1930 lm@4000 K/1810 lm@5700 K

²⁾ Value at 5700 K, different for other color temperatures

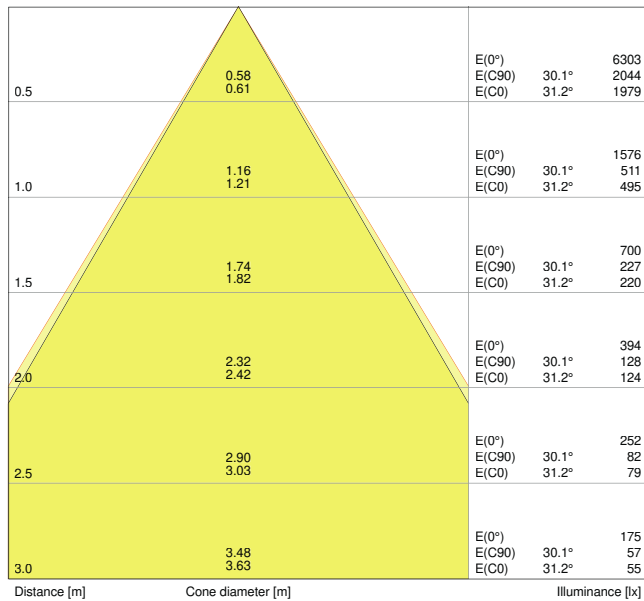

LDC typ cone

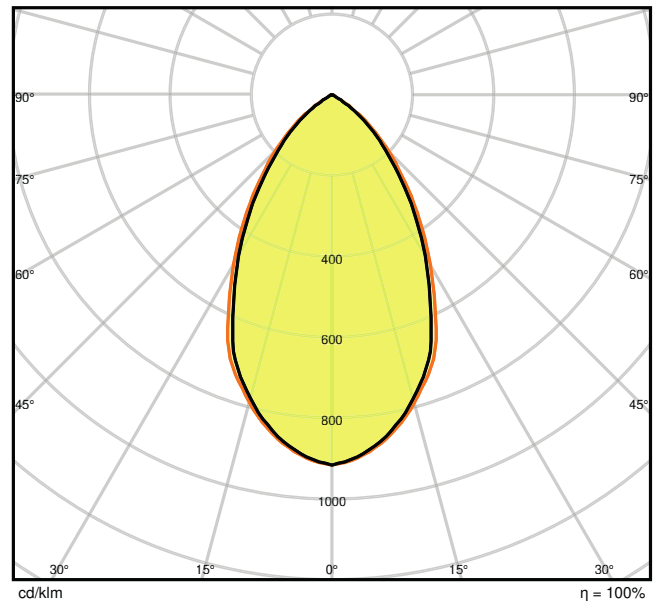

LDC typ polar

Dimensions & Weight

Diameter	228.00 mm
Height	98.00 mm
Product weight	550.00 g

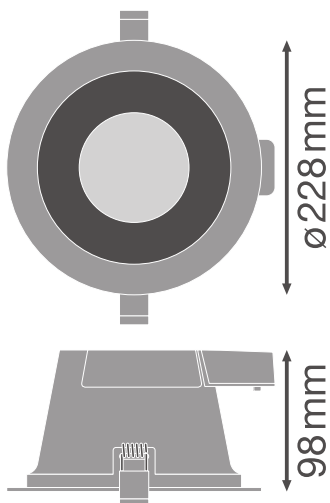

Materials & Colors

Product color	White
Housing color	White
Body material	Aluminum
Cover material	Polymethylmethacrylate (PMMA)
Glow Wire Test according to IEC 60695-2-12	650 °C
Mercury content	0.0 mg

Application & Mounting

Ambient temperature range	-20...+45 °C
Type of connection	Screwless terminal, 2-Pole
Type of protection	IP54/IP20
Protection class IK (shock resistance)	IK03
Dimmable	No
Mounting type	Recessed
Mounting location	Ceiling
Application environment	Indoor
Mounting diameter	205 mm
Mounting depth	125 mm
LED module replaceable	Not replaceable
With light source	Yes

Lifespan

Lifespan L70/B50 at 25 °C	50000 h ¹⁾
Lifespan L80/B10 at 25 °C	43000 h ¹⁾
Lifespan L90/B10 at 25 °C	30000 h
Number of switching cycles	50000

¹⁾ t[h]: L70 / B50 @ 25 °C (Ta), t[h]: L80 / B10 @ 25 °C (Ta), t[h]: L90 / B10 @ 25 °C (Ta)

Certificates & Standards





Standards	CE / CB / ENEC / TÜV SÜD
Luminaire with limited surface temperature, "D sign"	No
Ball shot safe	No

Additional product data



Number of illuminants	Not relevant
-----------------------	--------------

DOWNLOAD DATA

Documents and certificates

	User instruction
	Addon Technical Information
	Packaging insert
	Declarations Of Conformity CE
	Declarations Of Conformity UKCA

Photometric and lighting design files

	IES file (IES)
	LDT file (Eulumdat)
	ULD file (DIALux)
	ROLF file (RELUX)
	UGR file (UGR table)
	LDC typ cone
	LDC typ polar

Tender texts

	Tender documents
---	------------------

LOGISTICAL DATA

Product code	Packaging unit (Pieces/Unit)	Dimensions (length x width x height)	Gross weight	Volume
4058075104105	Folding box 1	250 mm x 250 mm x 140 mm	667.00 g	8.75 dm ³

Product code	Packaging unit (Pieces/Unit)	Dimensions (length x width x height)	Gross weight	Volume
4058075104112	Shipping box 8	520 mm x 520 mm x 300 mm	7050.00 g	81.12 dm ³

The mentioned product code describes the smallest quantity unit which can be ordered. One shipping unit can contain one or more single products. When placing an order, for the quantity please enter single or multiples of a shipping unit.

ADDITIONAL CATALOG INFORMATION

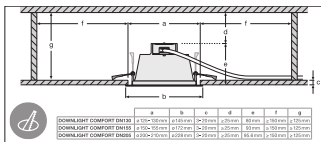
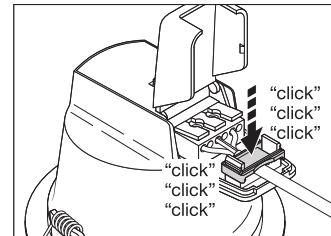
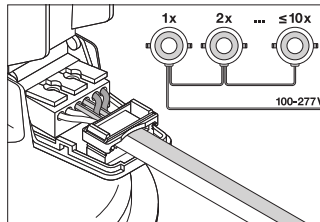
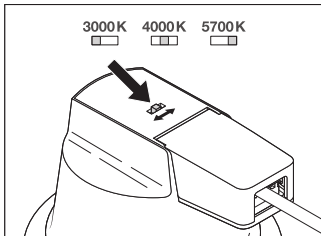

References / Links

- For Guarantee see www.ledvance.com/guarantee

DISCLAIMER

Subject to change without notice. Errors and omission excepted. Always make sure to use the most recent release.