

PRODUCT DATASHEET

FL PFM 50 W 4000 K SYM 100 WT

FLOODLIGHT 50 W | Versatile floodlight with up to 6000 lm light output



Areas of application

- Replacement for floodlights with halogen lamps
- Outdoor use (IP65)
- Public areas
- Building facades
- Construction areas
- Gardens, balconies and other outdoor areas

Product benefits

- Bright, robust and durable
- Safe and very uniform illumination, due to frosted and tempered glass diffuser
- No upper light output ratio (ULOR 0%) when mounted at 0° tilt
- Energy savings of up to 90 % compared to halogen lamp floodlights
- 5 years guarantee

Product features

- Reflector-based, symmetric light distribution with 100° x 100° beam angle
- Integrated wide voltage driver, suitable for 100 - 277 V AC
- Surge protection: up to 4 kV (L/N-PE), 2 kV (L-N)
- Mounting bracket with 30° angle and wide rotation area
- Breather membrane to optimize air exchange, without compromising IP protection
- Pre-installed, flexible 1 m cable (H05RN-F), wrapped 3 x 1.0 mm² single wires



TECHNICAL DATA

Electrical data

Nominal wattage	50.00 W
Nominal voltage	100...277 V
Mains frequency	50...60 Hz
Nominal current	236 mA
Inrush current	9.9 A
Inrush current time T_{h50}	51 μ s
Max. no. of lum. on circuit break. B16 A	38
Max. no. of lum. on circuit break. C10 A	28
Max. no. of lum. on circuit break. C16 A	44
Power factor λ	> 0.90
Total harmonic distortion	< 20 %
Protection class	I
Operating mode	Integrated LED driver

Photometrical data

Luminous flux	6000 lm
Luminous efficacy	120 lm/W
Color temperature	4000 K
Light color (designation)	Cool White
Color rendering index Ra	≥ 80
Standard deviation of color matching	≤ 5 sdc _m
Luminous intensity	-
Flickering metric (Pst LM)	-
Stroboscope effect metric (SVM)	-
Photobiological safety group acc. to EN62778	RG1
Photobiological safety group acc. to EN62471	RG1
Beam angle	100 ° x 100 °

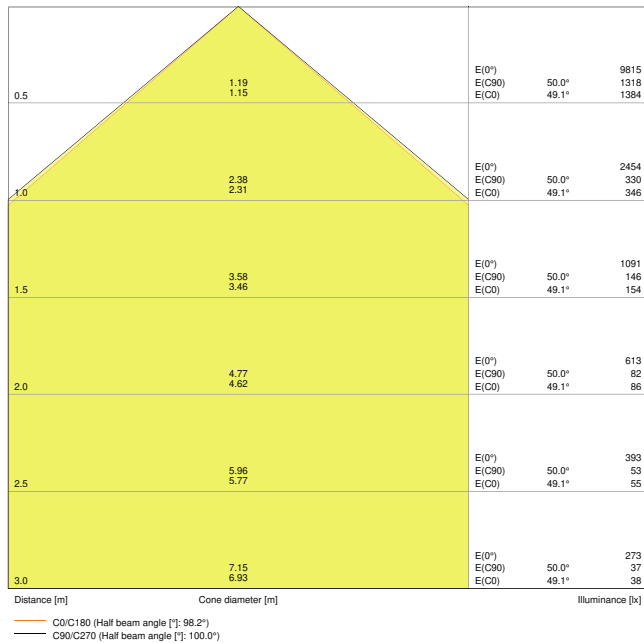

LDC typ cone

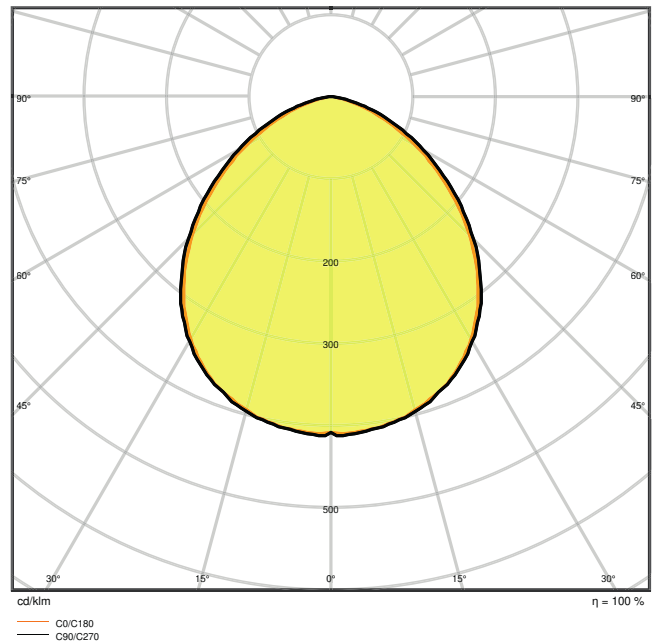

LDC typ polar

Dimensions & Weight

Length	206.00 mm
Width	218.00 mm
Height	46.00 mm
Product weight	1000.00 g
Cable length	1000 mm

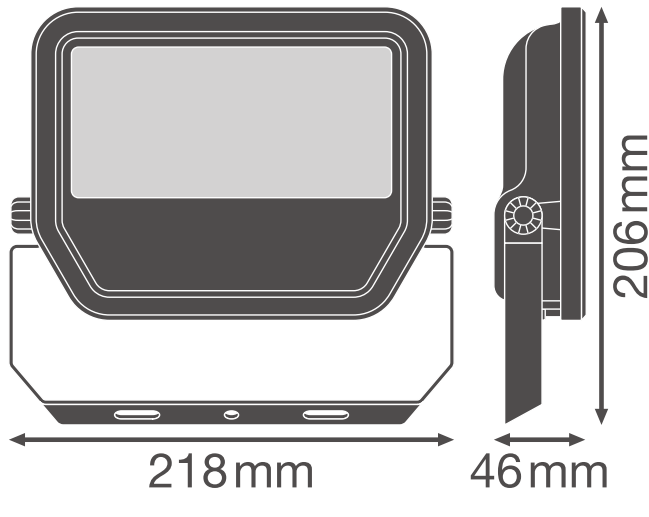

Product line drawing with numbers

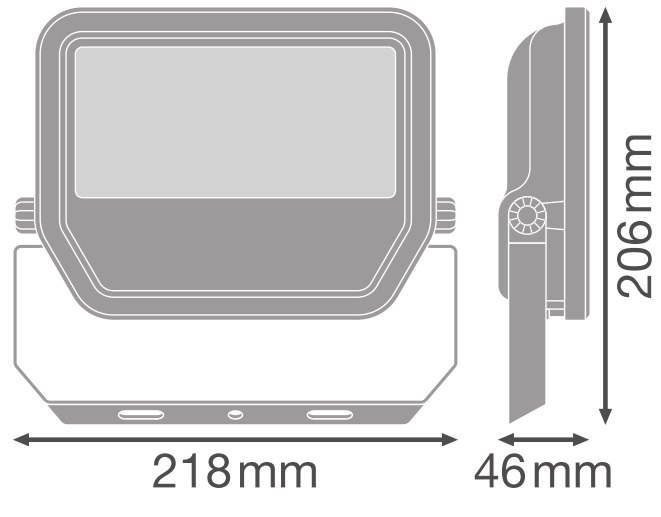

Product line drawing with numbers

Materials & Colors

Product color	White
Housing color	White
Body material	Aluminum
Light emitting surface material	Glass
Glow Wire Test according to IEC 60695-2-12	650 °C
Mercury content	0.0 mg

Application & Mounting

Ambient temperature range	-30...+50 °C
Temperature range at storage	-40...+70 °C
Type of connection	Cable, 3-pole
Type of protection	IP65
Protection class IK (shock resistance)	IK07
Dimmable	No
Mounting type	Surface
Mounting location	Wall / Ceiling / Floor
Application environment	Outdoor
Adjustable	Yes
LED module replaceable	Not replaceable

With light source	Yes
-------------------	-----

Lifespan

Lifespan L70/B50 at 25 °C	70000 h
Lifespan L80/B10 at 25 °C	55000 h
Lifespan L90/B10 at 25 °C	35000 h
Number of switching cycles	100000

Control gear





Output current	460 mA
ECG - Output ripple current	< 50 %

Certificates & Standards



Standards	CE / CB / ENEC / EAC / RoHS
Luminaire with limited surface temperature, "D sign"	No
Ball shot safe	No







DOWNLOAD DATA

Documents and certificates

	User instruction
	Addon Technical Information
	Packaging insert
	Declarations Of Conformity CE
	Declarations Of Conformity UKCA

Photometric and lighting design files

	IES file (IES)
	LDT file (Eulumdat)
	ULD file (DIALux)

Photometric and lighting design files	
	ROLF file (RELUX)
	UGR file (UGR table)
	LDC typ cone
	LDC typ polar
CAD/BIM files	
	CAD_STEP_3D
Tender texts	
	Tender documents

LOGISTICAL DATA

Product code	Packaging unit (Pieces/Unit)	Dimensions (length x width x height)	Gross weight	Volume
4058075421288	Folding box 1	224 mm x 67 mm x 181 mm	1107.00 g	2.72 dm ³
4058075421295	Shipping box 8	462 mm x 284 mm x 207 mm	9480.00 g	27.16 dm ³

The mentioned product code describes the smallest quantity unit which can be ordered. One shipping unit can contain one or more single products. When placing an order, for the quantity please enter single or multiples of a shipping unit.

ADDITIONAL CATALOG INFORMATION

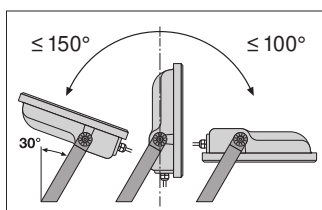

	A	B	C	⚙️	📄
10W	38	60	5.5	2x M4	0.014m ²
20W	38	80	8.5	2x M5	0.018m ²
30W	50	90	8.5	2x M5	0.021m ²
50W	78	110	8.5	2x M6	0.029m ²

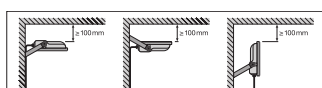
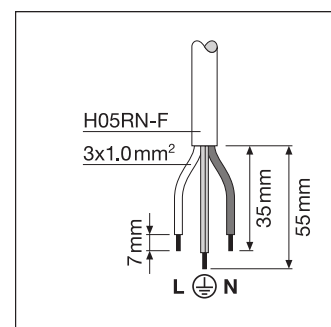

References / Links

- For Guarantee see www.ledvance.com/guarantee

DISCLAIMER

Subject to change without notice. Errors and omission excepted. Always make sure to use the most recent release.